

# Tactile Sensing Fingers Device Using Quantum Tunneling Composite (QTC) Pills

Ahsana Aqilah Ahmad<sup>1\*</sup>, Nur Izzah Lina Azaman<sup>1</sup>, Muhammad Azmi Ayub<sup>1</sup>

<sup>1</sup>Faculty of Mechanical Engineering, UiTM Shah Alam, Selangor, MALAYSIA

\*Corresponding author E-mail: [aqilah3739@salam.uitm.edu.my](mailto:aqilah3739@salam.uitm.edu.my)

## Abstract

This study investigated the potential of a material namely Quantum Tunneling Composite (QTC) pills as a tactile sensor. The properties and potential of QTC pill motivate this study to develop a new tactile finger device to increased muscle strength and functional ability of the hands. This is due to the health problems involving hand such as a stroke, Parkinson and carpal tunnel syndrome have difficulties to remain stable when grasping objects. QTC is a smart polymer matrix composite and a unique material. It acts as an insulator but in the highest compression exerted, it acts as a conductor. This is due to no electron can pass through this material when there is no compression. The experiments were conducted to investigate the sensitivity of the pills by plotting Force vs. Resistance graph. It is found out that these pills are capable to detect variation of force changing between 0gF to 500gF within 5seconds after loads are applied to the pills. In addition, the sensor glove device had also been designed using QTC Pills as a tactile sensor. Then, the prototype is used to evaluate three several types of gripping touches which are no gripping touch, light gripping touch, and heavy gripping touch of sphere shape objects (61.4g). The sensor should be able to detect the slightest changes in force exerted to the ball using this simple grasping action. The results are visualized by using myRIO hardware and labVIEW software. Force values of the gripping action are recorded for each finger; thumb, index, middle, ring and small finger. This work hopefully be able to assist in a rehabilitation process and use as a measurement tool to quantify the patient's hands gripping ability when compared to a healthy person.

**Keywords:** *Quantum Tunneling Composites (QTC) Pills, tactile sensor, resistivity, rehabilitation, Hand device*

## 1. Introduction

Further enhanced knowledge to robotic and medical researchers is essential in treating patients with fingers weakness. Besides that, it will also inspire and improve the quality of patients' life in daily activities. Therefore, patients with finger weakness require tactile sensor to monitor their rehabilitation and therapy process.

This study aims to investigate the potentials of QTC pill as tactile sensor, which is embedded on each glove fingertip. Thereby glove will be designed as a prototype tactile finger device. In addition, the tactile finger device is tested on a healthy person's right hand to simplify the analysis of performance of the device. This is because the prototype only records normal grasping data before it can be applied to the abnormal grasp.

The study also investigates three different touching grip forces for in gripping an object. The profiles of the gripping forces are compared during the task for a specified duration. This tactile device concept is still new and in the early development phase. It covers a broad perspective and a comprehensive system in order to obtain the knowledge necessary to continue development on the basis of previous research projects. [1, 2]

The first part of this paper is to investigate the sensitivity of the QTC Pills with respect to the force exerted on the pills. The aim is to determine what are the minimum values can be detected when using this material. Then, the prototype of sensor hand devices is developed to study the forces required to grasp a sphere shape material in each fingertip.

## 2. Literature Review

The human hand is a great invention and unable to be replicated by human beings. Its definition as according to H. Gray expressed that hand is the body part at the end arm which included fingers and thumb. Normal humans have five fingers which are thumb, index finger, middle finger, ring finger and little finger [3, 4]. Human beings use the hand to grasp, hold, and manipulate objects. For instance, they use the hand to perform precise actions such as writing a letter or to perform heavy labor. This is due to the hand being able to feel whether something is rough or smooth, hot or cold, and sharp or blunt [5]. Furthermore, it is also used to identify surface texture, weight, shape, size and thermal properties [6] of the object. Therefore, this upper limb is important to human beings in their daily life and should always be in a good and healthy. However, human can suffer serious health problems involving the hand, regardless of age. Among the serious illnesses are stroke, parkinson, carpal tunnel syndrome and others. Additionally, a human hand movement, skeleton and muscles are nothing without the tactile sensing involvement. R. L. Klatzky has described that a person with numb hands have difficulties to remain stable when grasping objects [7]. For that reason, it is crucial to study the anatomy of the human hand and movements to have a better understanding on human tactile sensing (sense of touch) and a stable grasp.

Physiotherapy is one way to recover these illnesses. Physiotherapy provides the necessary physical foundation where the function and survival of the weak hands can be reinvented. Advances in tech-

nology nowadays enable creation of variable tactile device to help the patients. For example, the devices have been developed to facilitate hand rehabilitation are Touch Sensitive Glove [8] and Pneumatic Glove (PneuGlove) [9]. Henceforth, the purpose of developing the tactile finger device in this study is to improve existing tactile device with the help of potential sensor with force as the main parameter to improve abnormal grasp and grip of the patients.

When designing tactile finger device, the force contribution by fingertip or hand is essential to be considered. The others finding of grasping and gripping force will be guideline to get information in evaluation phase in this study. The grip force information during grasping and object manipulation to adapt the fingertip forces published by Johansson and Westling [10] is 0-5N for light touch and 5-10N heavy touch. The adaptation of the grip force to different contact surfaces in their study are silk, suede and sandpaper. The grip force tested to 3 different loads in a healthy subject.



The material discovered by the scientist David Lussey is chosen for this study as a tactile sensor. It is a Quantum Tunneling Composite (QTC) Pills which exhibits piezoresistive-like behavior [11, 12], where the resistance changes with the changes in force. This behavior is a good point in any application of tactile sensor. The unique features of QTC suitable to develop a touch sensitive device and can be used to measure the patient's progress through therapy activities.

Therefore, the properties of QTC pill motivate this study to use it for replacing the old technology to develop new tactile finger device. To enable using QTC pill material to improve abnormal grasp and grip, this study will be conducted to characterize the nature of QTC pill as a tactile sensing application. Then, designing and developing the tactile finger device to evaluate the suitability of QTC pill as tactile sensor for the fingertip device. The success of this study will improve physiotherapy sector. Physiotherapy is one of the implementation of health services played an important role and responsibility in improving health, including problems with the study of limbs movement and function, prevention, healing, rehabilitative for the health of Malaysians.

**2.1. Commercially Available Tactile Sensor Device**

Table 1 shows available commercialize hand devices used for rehabilitation process. The types of sensor usage and product build-up is studied to come out with this research own hand device prototype.

**Table 1: Hand Devices**

Sensor device	Description
<p><b>Finger motion sensor</b></p> 	<p>Custom built set of finger motion sensors that allow us to measure, with high-sensitivity, the speed at which each of the fingers moves [13].</p>
<p><b>Music glove hand rehabilitation system</b></p> 	<p>The device has sensors built-in that detect the movement of the fingers. The user is given a video game to play by requiring the player to move fingers in tune with the music and on-screen buttons that light up [14].</p>
<p><b>Sensorized Glove for Measuring Hand Finger Flexion</b></p>	<p>System for measuring the finger position of one hand with the aim of giving feedback to the rehabilitation system [15].</p>

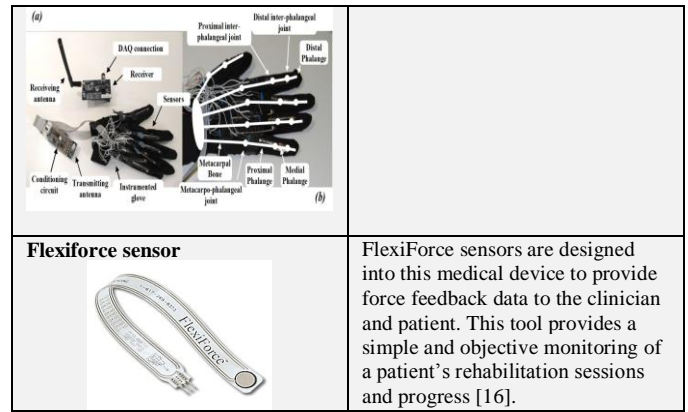

**FlexiForce sensor**



FlexiForce sensors are designed into this medical device to provide force feedback data to the clinician and patient. This tool provides a simple and objective monitoring of a patient's rehabilitation sessions and progress [16].

**3. Sensitivity of QTC Pills**

The measurement of the sensitivity of this material is done by measuring the resistance produce when force is applied to the pills. The size of the selected tiny QTC Pills is about 3.6mm x 3.6mm x 1mm and supplied by the "Science Geek" company. The pill is arranged in a sandwich layer as shown in Figure 1. When there is an external load exerted on the pills, the material can change the barrier potential and effectively change the resistance. Meanwhile, when no pressure is applied, the material acts as an insulator ( $10^{12} \Omega$ ).

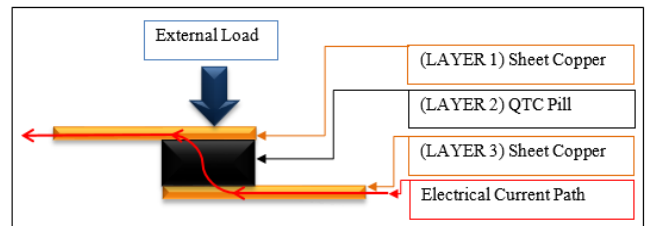

**Fig 1:** Sandwich contact between layers 1 and 3 produce new current path through layers 1, 2 and 3. Red arrows show electrical current paths.

Figure 2 shows the setup arrangement of the experiment. The setups is measured under a range between 0gF and 500gF using digital force gauge to find the sensitivity force value of QTC pill. The smallest range between 0gF to 500gF which equals to 0N to 5N is chosen for this setup to investigate the sensitivity of QTC pill in the smallest compression that occurs between 0N to 10N. Furthermore, simple task like gripping light object does not required high energy and force.

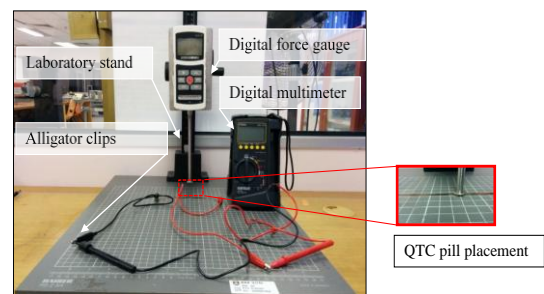

**Fig 2:** Force vs. Resistance Experimental Set-Up

**4. Prototype Design and Fabricating Sensor Device**

In this design (Figure 3), Velcro is used to attach QTC sensor on the glove. By using the Velcro, QTC sensor can be adjustable when holding different shapes of object. In the development of tactile finger device, cotton glove has been used to improve grip when handling slippery objects. The subject of this experiment is a

healthy 21 years old woman. The dimension of the subject hand is measured to ensure that the sensors are positioned correctly on the subject's fingertips.

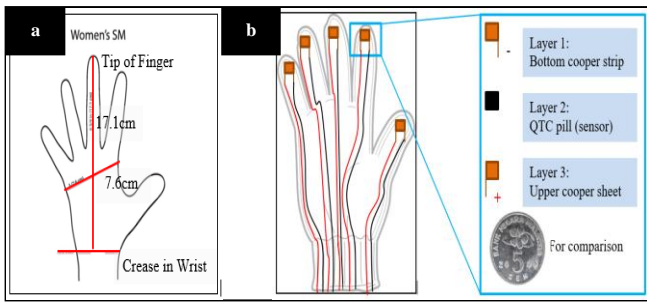

Fig 3: Hand devise prototype (a) the actual size of the subject hand (b) the position of the sensor

4.1. Force Sensor Circuit Design

The electrical circuit is built based on the recommended circuit [13] for QTC pill application which is arrangement force-to-voltage circuit. The circuit measure the force acting on the sensor when it is being compressed or touched. The voltage output can be measured and calibrated using the variable resistance regulators.

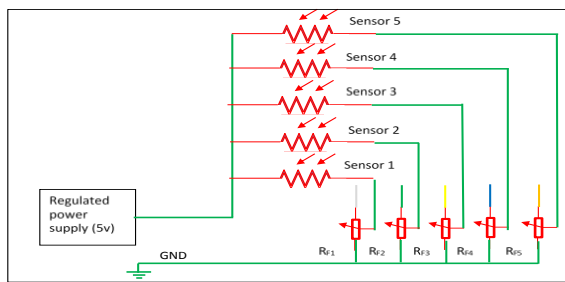





Fig 4: Circuit for Sensor Control

Figure 4 shows the connection components such as battery (9v), LED, diode, voltage regulator, capacitor (10F and 100F), variable regulator and sensor. The circuit design consisted of standard 9V batteries to power. Since the voltage supply was limited to 5V, the voltage regulator LM7805 is used.

5. Experimental and Performance Evaluation of The QTC Hand Device

Table 2: Procedure Description

		
Step 1: To get a "touch point" on the shape of workpiece, the fingers grip the object; then, define the touch points at the flat part of the fingertip.	Step 2: To ensure the touch points in permanent place, mark it with the sticker on the shape of workpiece.	Step 3: Sticker label for five fingers.

Solid sphere shape object is used for the proposed of this experiment. It is weighted 61.4g and gripping position for each finger is marked on the object surface to reduce the error during experiments. Table 2 describes how to obtain the "touch point" on the

object. This 'touch point' is the point of interaction between the fingertips and the surface objects. Three types of different gripping touches will be considered. They are no gripping touch, light gripping touch, and heavy gripping touch of objects. The experimental data obtained will be analysed using LabVIEW software. The data will be transferred to the DAQ and is displayed in real time on computer screen.

5.1. Signal Acquisition and Processing System

The basic structure (Figure 6) of this device consisted of five inputs and five outputs. The five inputs included QTC sensor located on the glove. The input is integrated with MXP and myRIO-1900 to receive input signal and provide controller mechanism. The five inputs will be calibrated to get the five outputs forces for the five fingers. The myRIO is programmed using LabVIEW myRIO software version 2014 for handling the input signal.

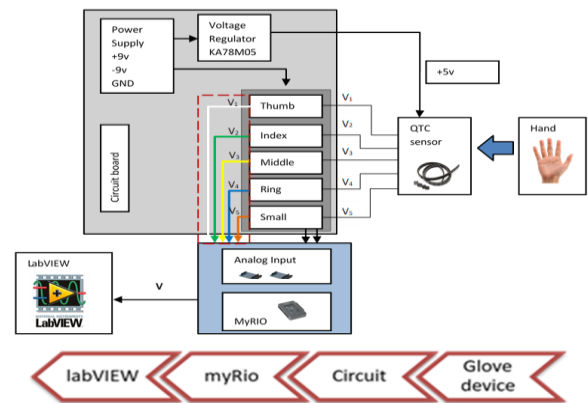

Fig 6: The flow of overall fingertip force system

The final stage of the experiment is receiving input from the myRIO data acquisition to display the result and data. The result is display at Graphical User Interface (GUI) also known as front panel (Figure 7).

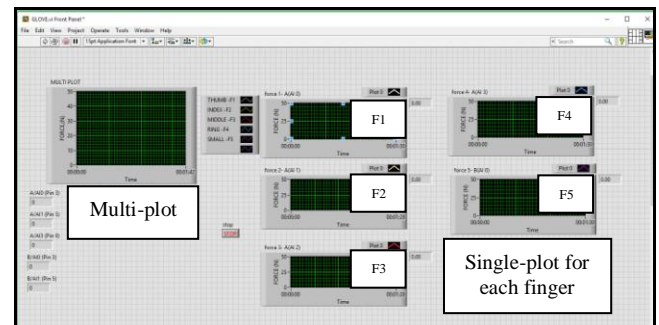

Fig 7: The front panel of system measurement

Front panel is function to manipulate the data including the minimum and maximum force through the specific time. The reading of sensor is read one by one. When the sensor device is holding the object, the data will come out as the signal flow at the front panel. For this experiment, there were no movements of signal flow because the sensor only holds the object.

Table 3: GUI's Fingers name display

Type of fingertip	Force (N)
Thumb	Force 1 (F1)
Index	Force 2 (F2)
Middle	Force 3 (F3)
Ring	Force 4 (F4)
Small	Force 5 (F5)

At the front panel, there are 5 forces displays for sensor output signal. Table 3 shows the forces for every fingertips sensor. Multi-



plot (Figure 7) on the other hand display all finger forces results in a single graph. By using LabVIEW, the programming can be understood easily because it used icon instead language program. The connecting between the icons builds the program. In the block diagram computer algorithm is written to control the output in the front panel.

## 6. Results and Discussion

### 6.1. Sensitivity Values of QTC Pills

**Table 4:** Resistance value for QTC Pills

Force (gF)	Force (N)	Pressure (N/m <sup>2</sup> )	RESISTANCE (Ω)
0	-	-	-
10	0.098	86.760	$7.28 \times 10^6$
100	0.981	867.604	$1.20 \times 10^5$
200	1.961	1735.207	$3.00 \times 10^2$
300	2.942	2602.811	$2.00 \times 10^2$
400	3.923	3470.415	$1.20 \times 10^2$
500	4.903	4338.018	$2.00 \times 10^1$

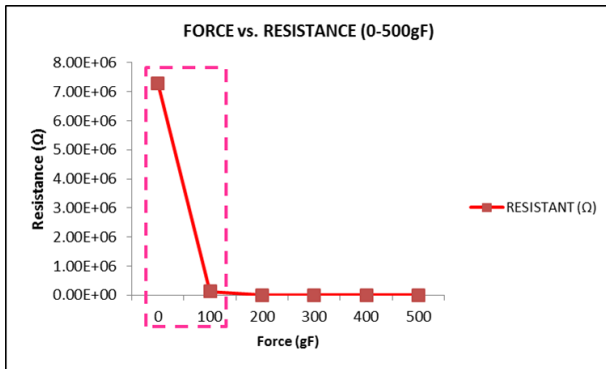

**Fig 8:** Sandwich Contact Arrangement Force vs. Resistance (0gF to 500gF)

The result presented in Table 4, at 10gF, the resistance shown the highest value at  $7.28 \times 10^6\Omega$ , while at 500gF, it recorded the lowest value at  $2.00 \times 10^1\Omega$ . The data also shows there is a sudden declination between 10 to 100gF. Figure 8 shows that the QTC pill is very sensitive within range 0gF to 100gF.

The graph estimation is linear line but instead it is reverse exponential graph. It is proven by manipulating a small applied force from 0gF to 100gF as in Figure 9 to obtain new resistance value within this range.

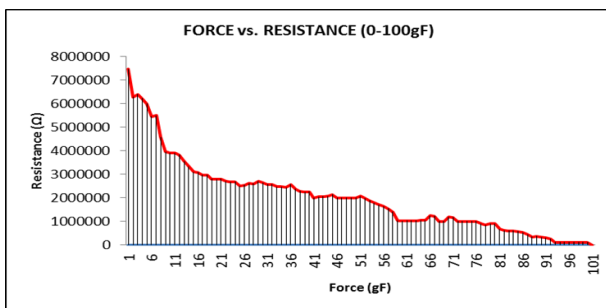

**Fig 9:** Force vs. Resistance (0-100gF)

Figure 9 represented the resistance value is exponential and it is fluctuating. As theory explained, in the normal state which is zero compression, the material will be in a perfect insulator while resistance will be limitless. Then, based on investigation of QTC force vs. resistance, an exponential curve graph result was obtained, which was different from other piezoresistive materials. This is coherent with the hypothesis of quantum tunneling charge transport within the polymer.

This is because the effect exhibited by QTC Pill is strong and extremely responsive to deformation existence of nickels. The hypothesis is further supported by the study of the Current-Voltage (IV) curve using sandwich contact arrangement. From this experiment, the resistance values can be obtained within 5 seconds after loads have been applied. It shows that QTC Pills are capable to be used as a sensitive sensory material that detects the smallest values of force.

Next, after obtaining this result, experimental work will be directed toward investigating force value on each finger tips when performing simple gripping action using the prototype hand device. This experiment cannot be done using commercialize hand devices because the range of force detected is too big for this simple gripping task.

### 6.2. Force Values using Fingertips Hand Devices

The results obtained is based on three types of touch which are no touch, light touch and heavy touch. No method is used to indicate specific value between these touches. It is based on the subject own normality when doing this task in his/her daily activity. The experiment is repeated 10 times and the best three minutes reading is taken and analysed.

#### 6.2.1. No Touch

Figure 10 shows the result for no touching contact between the fingers and the objects. There should be no value (0N) recorded since no interaction involved between the fingers and the object during the experiment. However, the tactile sensor gives a range of data between 0.554N and 0.379N. This is due to presents of noises or interfering frequency in the circuit system. The source of the noises are due to the Electromagnetic Interference, since the measurements were carried out near to the other electrical devices such as power supply and computer. Moreover, the components of the sensor board were connected using electrical wiring which probably act as an antenna that trap the external frequencies and affects an electrical circuit. However, the value is very small and can be ignored.

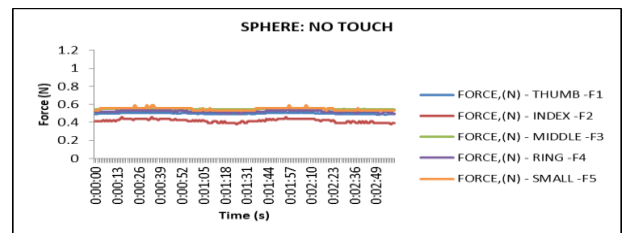

**Fig 10:** Graph Average Force vs. Time No Touch gripping

#### 6.2.2. Light Touch

The result obtained in Figure 11 is between 0.442N to 4.198N when light touching is applied to the object. The highest and the second highest forces obtained are 4.198N and 3.472N which are from index finger and thumb respectively.

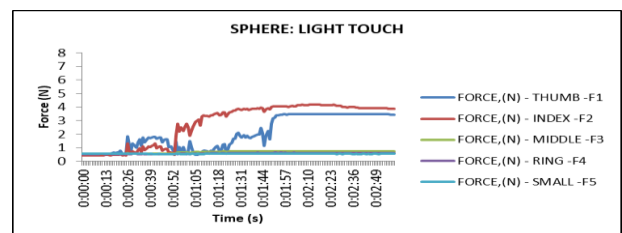
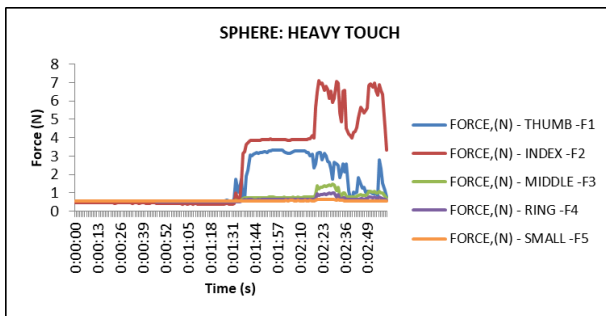

**Fig 11:** Graph Average Force vs. Time Sphere Light Touch; Thumb (Max: 3.472N; Min: 0.501N), Index (Max: 4.198N; Min: 0.442N), Middle (Max: 0.768N; Min: 0.551N), Ring (Max: 0.650N; Min: 0.516N), and Small (Max: 0.588N; Min: 0.533N)

From the result, it shows that the significant finger involved in 'light touch' of gripping the sphere object are F2 and F1 while the smallest force is at F5, little finger. This indicates that the index finger and the thumb play an important role in gripping this object compared to other fingers.

### 6.2.3. Heavy Touch

Similar to light touch, the heavy touch as in Figure 12 also shows that index and thumb finger give the highest result respectively. In heavy touch, 0.7111N index finger obtained the highest value, followed by thumb which is 0.364N. The middle and ring fingers showed the increasing of force, but little finger had no significant changes. The heavy touch obtained the highest force compared to no touch and light touch. Figure 12 shows the graph of average values for heavy touch task.



**Fig 12:** Graph Average Force vs. Time Sphere Heavy Touch; Thumb (Max: 3.339N; Min: 0.490N), Index (Max: 7.111N; Min: 0.364N), Middle (Max: 1.472N; Min: 0.544N), Ring (Max: 1.011N; Min: 0.499N), and Small (Max: 0.616N; Min: 0.533N)

### 6.2.4. Summary for Each Fingertip Touches

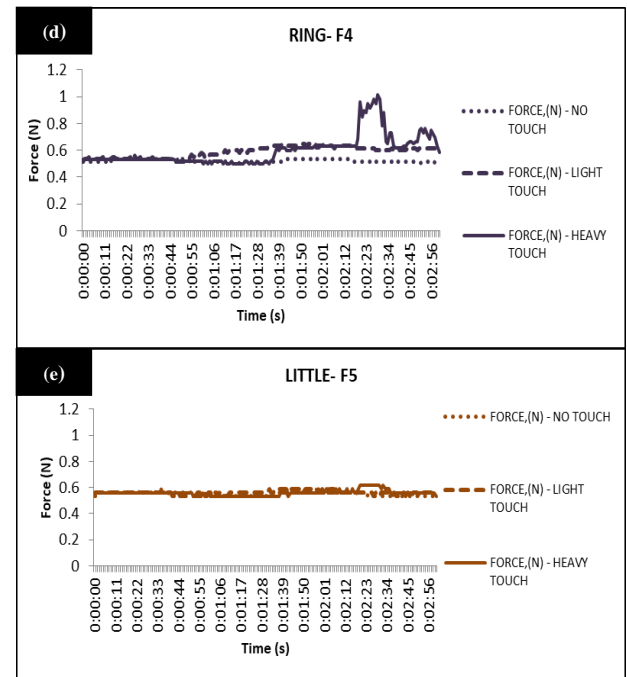
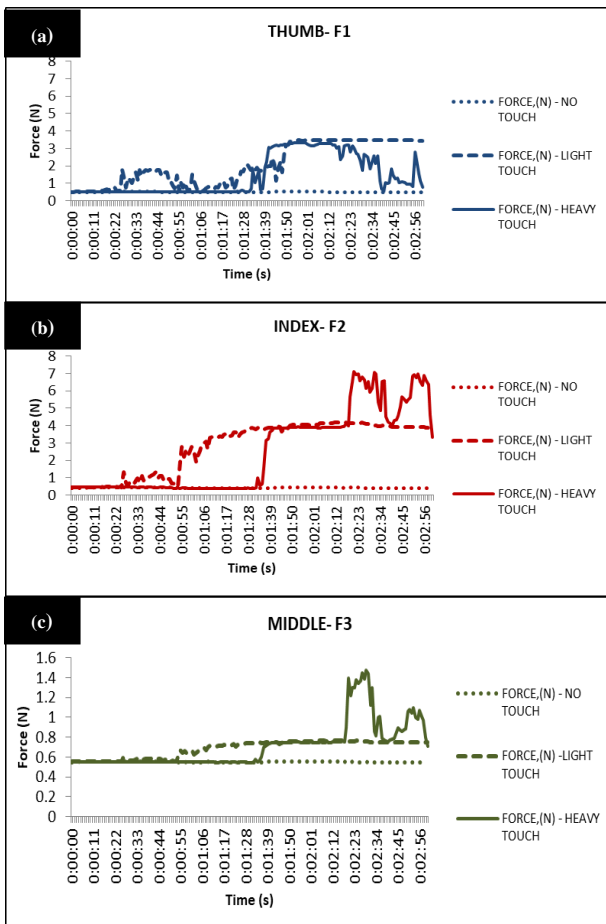

**Fig 13:** Average force value for (a) Thumb, (b) Index, (c) Middle, (d) Ring and (e) Little Finger

Figure 13 (a) – (e) represents a summary on fingertip touches. As can be seen in these figure, it shows index finger (F2) contributes the highest value of force exerted to the object in gripping action, followed by thumb (F1), middle (F3), ring (F4) and finally little finger (F5) contributes the lowest or no force required.

## 7. Conclusion

The experiments were conducted to investigate the sensitivity of the pills by plotting Force vs. Resistance graph. Based on the material's product specification, the range of forces this material can handle are between 0 to 100N [10]. Since normal task like gripping light object needs little energy/ force, hence this experiment is to investigate the behaviour of this material with respect to the force below 10N which is equivalent to 1kg.

From the data obtained can be conclude that the sensitivity of the tactile sensor varies from the range as small as 10gF (0.098N) and up to 100gF (0.981N). At 10gF the resistant produce is  $7.28 \times 10^6 \Omega$ , while at 100gF, the resistant is  $1.20 \times 10^5 \Omega$ . This is in-line with the theory that the higher the resistant, the more difficult for the electron to flow in QTC pill. It shows the capability of this material to detect very small changes in force.

Finally, hand devices prototype is developed using QTC Pills to explore the value of forces each finger experience when gripping light object as in their daily life activities. Three types of different gripping touches which are no gripping touch, light gripping touch, and heavy gripping touch of objects was evaluating by tactile finger device. In addition, the experimental data obtained by analysing using LabVIEW software. The data transferred to the DAQ and displayed in real time on computer screen.

In this experiment the subject is doing a simple task of gripping sphere shape object using the hand device. It shows that the maximum value of force detected when gripping this object is 8N and thumb and index finger play a major role in gripping this object.

In conclusion, QTC pills is a promising material that can be used in variety of areas especially in tactile sensing application. The hand device on the other hand hopefully be able to assist in a rehabilitation process and use as a measurement tool to quantify the patient's hands gripping ability when compared to a healthy person.

## Acknowledgement

This paper contributes for grant, RAGS 600-RMI/RAGS 5/3 (161/2014) Ministry of Education Malaysia, and Faculty of Mechanical Engineering Universiti Teknologi MARA (UiTM) Shah Alam, Malaysia.

## References

- [1] A. A. Ahmad, C. Y. Low, N. Muthmainnah, and A. Jaffar, "Measurement of quantum tunneling composite resistivity characteristics for tactile sensing applications," *Jurnal Teknologi*, vol. 76, pp. 43-47, 2015.
- [2] N. I. L. Azaman, M. A. Ayub, and A. A. Ahmad, "Characteristic and sensitivity of Quantum Tunneling Composite (QTC) material for tactile device applications," in *Control and System Graduate Research Colloquium (ICSGRC), 2016 7th IEEE*, 2016, pp. 7-11.
- [3] H. Gray, *Anatomy of the human body: Lea & Febiger*, 1918.
- [4] HEALTHLINE. (25 August 2015). *Hand Anatomy, Pictures & Diagram | Body Maps*. Available: <http://www.healthline.com/human-body-maps/distal-phalanges-hand>
- [5] C. MacKenzie and T. Iberall, "The grasping hand (Vol. 104)," *Access Online via Elsevier*, 1994.
- [6] L. A. Jones and S. J. Lederman, *Human hand function: Oxford University Press*, 2006.
- [7] R.L. Klatzky, S.J. Lederman, *Touch*, in *Experimental Psychology*, ed. by A.F. Healy, R.W. Proctor. *Handbook of Psychology*, vol. 4 (Wiley, New York, 2003), pp. 147-176
- [8] J. Hallam and V. Whiteley, "Interactive therapy gloves: reconnecting partners after a stroke," in *CHI'11 Extended Abstracts on Human Factors in Computing Systems*, 2011, pp. 989-994.
- [9] L. Connelly, Y. Jia, M. L. Toro, M. E. Stoykov, R. V. Kenyon, and D. G. Kamper, "A pneumatic glove and immersive virtual reality environment for hand rehabilitative training after stroke," *IEEE Transactions on Neural Systems and Rehabilitation Engineering*, vol. 18, pp. 551-559, 2010.
- [10] R. S. Johansson, G. Westling, "Coordinated isometric muscle commands adequately and erroneously programmed for the weight during lifting task with precision grip." *Experimental Brain Research*. 71, 59-71 (1988).
- [11] R. S. Dahiya and M. Valle, *Robotic tactile sensing: technologies and system: Springer Science & Business Media*, 2012.
- [12] P. Ltd., "Peratech QTC® Multi-force," 2012.
- [13] Schaechter, Judith D., Christopher Stokes, Brendan D Connell, Katherine L. Perdue and Giorgio Bonmassar. "Finger motion sensors for fMRI motor studies." *NeuroImage* 31 4 (2006): 1549-59
- [14] P. M. and Rehabilitation, "Music Glove for Hand Therapy," UPMC HealthBeat, 20-Apr-2016. [Online]. Available: <https://share.upmc.com/2015/12/music-glove-for-hand-therapy/>. [Accessed: 16-Aug-2018].
- [15] M. Borghetti, E. Sardini and M. Serpelloni, "Sensorized Glove for Measuring Hand Finger Flexion for Rehabilitation Purposes," in *IEEE Transactions on Instrumentation and Measurement*, vol. 62, no. 12, pp. 3308-3314, Dec. 2013. 15
- [16] "Force Sensor-Enabled Rehabilitation Device for Rheumatic Patients," *Tekscan*, 20-Mar-2018. [Online]. Available: <https://www.tekscan.com/applications/force-sensor-enabled-rehabilitation-device-rheumatic-patients>. [Accessed: 16-Aug-2018].
- [17] D. Campolo, E. S. Maini, F. Patane, C. Laschi, P. Dario, F. Keller, et al., "Design of a sensorized ball for ecological behavioral analysis of infants," in *Robotics and Automation, 2007 IEEE International Conference on*, 2007, pp. 1529-1534.