

# An experimental investigation of heat transfer characteristics of water based $\text{Al}_2\text{O}_3$ nanofluid operated shell and tube heat exchanger with air bubble injection technique

Gaurav Thakur <sup>1\*</sup>, Gurpreet Singh <sup>2</sup>

<sup>1</sup> Research Scholar, Chandigarh University, Punjab

<sup>2</sup> Assistant Professor, Chandigarh University, Punjab

\*Corresponding author E-mail: [gt211991@gmail.com](mailto:gt211991@gmail.com)

## Abstract

The thermal performance of shell and tube heat exchangers has been enhanced with the use of different techniques. Air bubble injection is one such promising and inexpensive technique that enhances the heat transfer characteristics inside shell and tube heat exchanger by creating turbulence in the flowing fluid. In this paper, experimental study on heat transfer characteristics of shell and tube heat exchanger was done with the injection of air bubbles at the tube inlet and throughout the tube with water based  $\text{Al}_2\text{O}_3$  nanofluids i.e. (0.1%v/v and 0.2%v/v). The outcomes obtained for both the concentrations at two distinct injection points were compared with the case when air bubbles were not injected. The outcomes revealed that the heat transfer characteristics enhanced with nanoparticles volumetric concentration and the air bubble injection. The case where air bubbles were injected throughout the tube gave maximum enhancement followed by the cases of injection of air bubbles at the tube inlet and no air bubble injection. Besides this, water based  $\text{Al}_2\text{O}_3$  nanofluid with 0.2%v/v of  $\text{Al}_2\text{O}_3$  nanoparticles gave more enhancement than  $\text{Al}_2\text{O}_3$  nanofluid with 0.1%v/v of  $\text{Al}_2\text{O}_3$  nanoparticles as the enhancement in the heat transfer characteristics is directly proportional to the volumetric concentration of nanoparticles in the base fluid. The heat transfer rate showed an enhancement of about 25-40% and dimensionless exergy loss showed an enhancement of about 33-43% when air bubbles were injected throughout the tube. Moreover, increment in the heat transfer characteristics was also found due to increase in the temperature of the hot fluid keeping the flow rate of both the heat transfer fluids constant.

**Keywords:** Shell and Tube Heat Exchanger;  $\text{Al}_2\text{O}_3$ /Water Based Nanofluids; Heat Transfer Coefficient; Overall Heat Transfer Coefficient; Nusselt Number.

## 1. Introduction

The growing demand and confined sources of energy have forced the engineers to develop various techniques to enhance the heat transfer coefficient that ultimately enhances the performance of heat exchangers [1]. It has been estimated by the world energy council that there would be around 50% rise in energy demand because of rapid development in industrialization in the coming years [2]. Heat exchangers have played an important role to conserve energy by reusing this conserved energy for various purposes. Its not only to extract maximum possible energy with the help of improved heat exchangers but they also help in saving the operating cost and investment of the system[3].

Shell and tube heat exchangers are extensively being found their usage in industries due to the factors such as easy manufacturing, easy maintenance, ability to handle high pressure (up to 6000 psi) and temperature (-250°C to 800°C). They are being widely used in power plants, food processing industries, chemical and petrochemical industries, manufacturing, etc.

There are various techniques that have been utilized to improve the thermal performance of shell and tube heat exchangers. The Air bubble injection is one such technique but passive one to enhance the heat transfer rate. Air bubbles are induced to any flowing fluid channels to maximize the heat transfer characteristics of the fluid. As per the different studies, the bubble dynamics creates much impact on the wall skin friction drag. Injecting bubbles in

the flowing fluid reduces the density of the liquid that leads to the generation of baroclinic vorticity on larger scale. For a laminar flow, the bubbles create turbulence in the flow and hence cause a higher heat transfer by reducing the skin friction drag around the wall. However in the case of a turbulent flow, smaller bubble doesn't create much effect while larger bubbles create more impact. They can penetrate much to the turbulent flow and reduces the skin friction drag. While bubble flows along with the flowing fluid, it creates a void, which is filled by the fluid surrounding the bubbles. This creates extra turbulence and allows more heat to be carried out from the surfaces by the cooling fluid. A bubble can be injected at the nucleation site, throughout the flow or in the middle of the flow depending on the requirement. It is one of the simplest method which is cheaper, environmental friendly and easy to maintain. It doesn't include any complicated system to handle. This method can be wisely and widely being used in order to enhance the performance of any system involving heat transfer process. [4]

Celeta et al. [5] studied the effect of air bubble injection at the entrance of a heated channel and reported an increment by 10 times in the heat transfer rate. Dizaji and Jafarmadar [6] reported an enhancement of 10-40% in effectiveness and 6-35% enhancement in Nusselt number in a double pipe heat exchanger due to air bubble injection. Gabillet et al. [7] studied the effect of bubbles over the velocity and turbulence of the flowing fluid and reported an increase in turbulence and velocity of the flow with air bubble injection. Jiagai et al. [8] explained how the bubble reduces the

skin friction drag in boundary layers. Mattson and Mahesh [9] studied the effect of bubble size on the turbulence and revealed that larger bubble can penetrate to more distance in a turbulent flow while the smaller size bubble just produces effect near the wall or the point of generation. Jacob et al. [10] thoroughly investigated the effect of bubbles and reported that the shear stress and the Reynolds stress near the wall for the two-phase flow have been reduced with the downstream of injection as compared to single phase flow. A.Nandan and G.singh [11] studied the effect of air bubble injection over the heat transfer characteristics in shell and tube heat exchangers and reported enhancement of performance of shell and tube heat exchanger. Kern [12] Introduced first procedure to design a shell and tube heat exchanger. It has been found that the different techniques have been utilized to improve the performance of the shell and tube heat exchangers such as providing fins, different tube geometry, tubulators etc. studies have been conducted on the effect of baffle height, flow pattern and baffles spacing on the effectiveness of shell and tube heat exchangers [13]. Nanofluids have also been applied to enhance the performance of the heat exchangers. Nanofluid is a fluid that contains suspended solid nanoparticles of metals or non-metals whose size is generally less than 100nm. Heat exchanger containing nanofluid gives better heat transfer characteristics than heat exchanger containing conventional fluids because of the fact that the thermal conductivity of solids is better than the liquids. This property of nanofluid having high thermal conductivity than conventional fluids make them future heat transfer fluids in heat exchangers or other suitable thermal equipment [14]. S.M. Fotukian and M. Nasr Esfahany [15] studied the effect of very dilute (less than 0.24% volume) CuO/water nanofluid on the heat transfer coefficient and pressure drop. He found that the inclusion of small amounts of CuO nanoparticles to the base fluid caused 25% increase in heat transfer coefficient and 20% penalty in pressure drop. Yajie Ren et al. [16] proposed a theoretical model to calculate the effective thermal conductivity of nanofluids considering the effects of an interfacial layer formed between particle and liquid interface and convection (micro) caused by thermal motion of nanoparticles. The suspended nanoparticle size, volume fraction, temperature and thermal conductivities of the nanoparticle and base fluid were the parameters taken in to account while calculating the enhancement in effective thermal conductivity of a nanofluid. It was found that the predicted results were similar to recently available experimental data. L.Syam Sundar et al. [17] experimentally estimated the thermal conductivity of ethylene glycol and water mixture (50:50) based low volume concentration of CuO and Al<sub>2</sub>O<sub>3</sub> nanofluids at different volume concentrations and temperatures. It was found that the thermal conductivity of CuO is more compared to Al<sub>2</sub>O<sub>3</sub> under same volume concentration and temperature. K. Rohini Priya et al. [18] studied the thermal conductivity of 0.016 vol% CuO-water nanofluid at 28°C and 55°C and they found the thermal conductivity enhancement of 13% at 28°C and 44% at 55°C. Xiaohao Wei et al. [19] synthesized the water based Cu<sub>2</sub>O nanofluids with the help of chemical solution method and experimentally studied the effect of reactant molar concentration and nanofluid temperature on the thermal conductivity. It was found that synthesized nanofluids can enhance thermal conductivity up to 24%. The thermal conductivity also showed sensitivity and non-linearity to the reactant molar concentration and nanofluid temperature. Various thermal transport properties of nanofluids depend on nanoparticle concentration and fluid temperature [20, 21]. Gaurav Thakur and Gurpreet Singh [22] found the great enhancement in heat transfer characteristics inside nanofluid operated shell and tube heat exchanger with air bubble injection.

The objective of this paper is to find out the effect of air bubble injection over the heat transfer characteristics in shell and tube heat exchangers containing water based Al<sub>2</sub>O<sub>3</sub> cold nanofluid with two different volumetric concentrations of Al<sub>2</sub>O<sub>3</sub> nanoparticles (0.1%v/v, 0.2% v/v) on tube side and hot water on shell side. Earlier studies have shown that air bubble injection technique is never

applied to the shell and tube heat exchanger containing Al<sub>2</sub>O<sub>3</sub> – water based nanofluid as one of the heat transfer fluids.

## 2. Nanofluids preparation

Nanofluids are basically prepared by two methods named as one step method and two step method. In present work, two step method is used to prepare water (distilled) based Al<sub>2</sub>O<sub>3</sub> nanofluids with two different volumetric concentrations of Al<sub>2</sub>O<sub>3</sub> nanoparticles (0.1%v/v, 0.2% v/v). The average size of Al<sub>2</sub>O<sub>3</sub> nanoparticles taken was 20 nm. The equation 1 is used to evaluate the required volumetric concentration of nanoparticles in the water base fluid.

$$\phi = \frac{\frac{m_p}{\rho_p}}{\frac{m_p}{\rho_p} + \frac{m_f}{\rho_f}} \quad (1)$$

The nanoparticles were completely mixed in the base fluid using magnetic stir. In order to remove the agglomerations, nanofluids sonicated in the ultrasonicator for about 2 hours. Since the nanoparticles mixed with the base fluid completely, the addition of surfactant to stabilize the nanofluids was not needed. After completely preparing the both sets of nanofluids, the thermo-physical properties of nanofluids were determined. The thermo-physical properties of nanofluids were determined using the following steps.

## 3. Experimental setup

The set up used for the analysis of the experiment is shown in figure 1 and figure 2 shows the schematic diagram of the experimental set up. The experimental set up consists of hot water loop containing distilled water, air injection system, cold water loop containing water based Al<sub>2</sub>O<sub>3</sub> nanofluids with two different volumetric concentrations (0.1%v/v and 0.2% v/v) taken one after another and test section.



Fig. 1: Experimental Set up.

The K-type thermocouples of accuracy of about  $\pm 0.1^\circ\text{C}$  were connected at the inlet and outlet of the tube and shell. To obtain the wall temperature, thermocouples (accuracy  $\pm 0.1^\circ\text{C}$ ) were also installed on the wall surface of shell and tube heat exchanger.

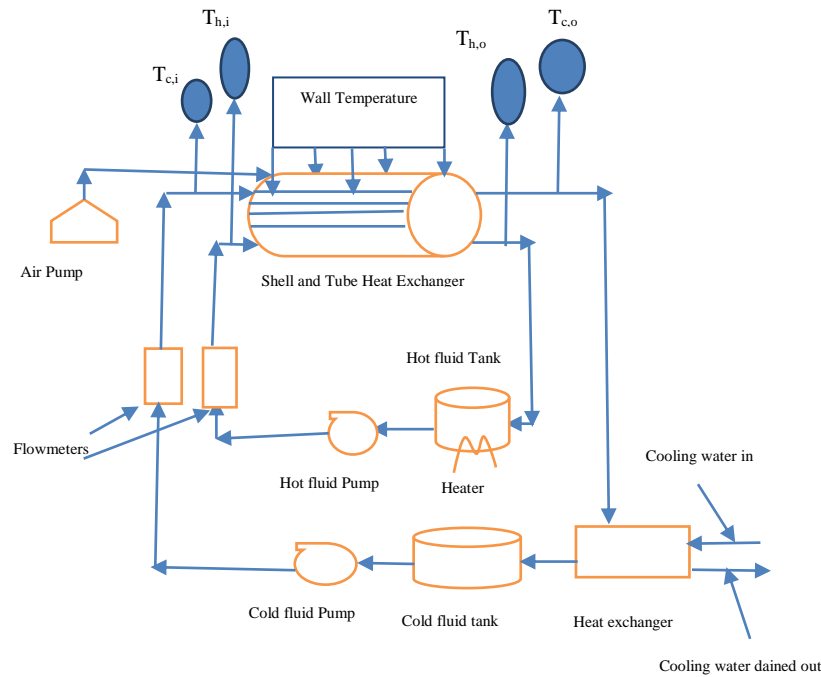


Fig. 2: Schematic Diagram of Experimental Set Up.

Table 1 shows the Specifications of the test section taken under consideration.

Table 1: Specifications of Test Section

Dimensions	Value
Length(mm)	600
Shell diameter (mm)	53
Tube inner diameter (mm)	10
Tube outer diameter (mm)	12.5
No of Tubes	4

Distilled water is being heated in the hot water tank with five litre capacity. In order to control the temperature of hot water, a controller known as PID (Proportional-integral-derivative) controller of accuracy  $\pm 1^\circ\text{C}$  is used. Hot water is pumped to the shell side at variable flow rates (0.5, 1, 1.5, 2, 2.5, 3, 3.5 lpm) and at variable temperatures (30°C, 40°C, 50°C and 60°C). Water based  $\text{Al}_2\text{O}_3$  cold nanofluid with two different volumetric concentrations of  $\text{Al}_2\text{O}_3$  nanoparticles (0.1% v/v and 0.2% v/v taken one after another) is being pumped at an invariable flow rate of 3.5 lpm with fixed temperature. In order to regulate the flow rate on both the tube side and shell side, two flow meters were installed on both the sides with an accuracy of about 1%. The range and the accuracy of the components used are shown in table 2.

Table 2: Accuracy of Component

Components	Accuracy
Thermocouples	0.1°C
Flow meter	1%
PID	0.25%

The aquarium pump was used for injecting the air with a constant mass flow rate of 0.05833 kg/sec with an almost negligible pressure as compared to the pressure created by the flow of water at an ambient temperature of 15°C. The experiments were performed in three different runs. The first experiment was performed considering water based  $\text{Al}_2\text{O}_3$  cold nanofluid on tube side and the hot water on the shell side. Distinct readings were noted down at seven regular intervals of time and analysis is done on the basis of the average of the readings taken.

In the second group of experiments, the air and water based  $\text{Al}_2\text{O}_3$  nanofluid is made to enter the tube inlet. For each case, distinct

readings were noted down at seven regular intervals of time and analysis is done on the basis of the average of the readings taken. The third group of experiments was performed by injecting the air bubbles throughout the tube carrying water based  $\text{Al}_2\text{O}_3$  nanofluid and hot water was allowed to flow through the shell side. Before inserting the air bubbles throughout the tube, a very small diameter plastic tube with several holes was inserted inside or throughout the tube. All the above three cases were performed two times, one with 0.1% v/v of  $\text{Al}_2\text{O}_3$  nanoparticles in the water base fluid and other with 0.2% v/v of  $\text{Al}_2\text{O}_3$  nanoparticles in the water base fluid.

#### 4. Data processing

Heat transfer characteristics such as heat transfer rate, exergy loss, dimensionless exergy loss and NTU (Number of Transfer Units) are evaluated to analyze the effect of air bubble injection technique applied to the shell and tube heat exchanger.

Reynolds number is evaluated by using the following equation (2)

$$\text{Re} = \frac{\rho v d}{\mu} \quad (2)$$

The heat transfer rate is evaluated using the following equations from (3) – (5)

$$Q_{avg} = \frac{1}{2}(Q_h + Q_c) \quad (3)$$

$$Q_c = m_c \times C_{pc} \times (T_{c,o} - T_{c,i}) \quad (4)$$

$$Q_h = m_h \times C_{ph} \times (T_{h,i} - T_{h,o}) \quad (5)$$

Akpınar and Bicer[18] methods are used to evaluate the exergy loss and dimensionless exergy loss represented by the equations from (6) – (10) below

$$E_h = T_a \left\{ m_h \times C_{ph} \times \ln \frac{T_{h,o}}{T_{h,i}} \right\} \quad (6)$$

$$E_c = T_a \left\{ m_c \times C_{pc} \times \ln \frac{T_{c,o}}{T_{c,i}} \right\} \quad (7)$$

$$E = E_h + E_c \quad (8)$$

$$e = \frac{E}{T_a \times C_{min}} \quad (9)$$

$$C_{min} = \text{Min} \{C_h \& C_c\} \quad (10)$$

The following equation (10) is used to calculate the NTU (Number of Transfer Units)

$$NTU = \frac{A_o \times U_o}{C_{min}} \quad (11)$$

Where,

$$C_{min} = \text{Min} \{C_h \text{ and } C_c\}$$

$$C_h = m_h \times C_{ph} \quad (12)$$

$$C_c = m_c \times C_{pc} \quad (13)$$

## 5. Results and discussions

### 5.1. Effect on the heat transfer rate

The thermal performance of any heat exchanger is depicted by the amount of heat transferred between the hot and the cold fluid. The heat transfer rate usually occurs due to temperature difference taking place between the hot and the cold side. From the equations (3) & (4), it has been seen that the heat transfer rate is directly proportional to the temperature difference. From the experimental investigation, heat transfer rate was found to be enhanced with the increase in the Reynolds Number. The air bubbles were injected at different points that showed an increment in the heat transfer rate when compared to the case when no air bubble was injected. The air bubbles injected throughout the tube showed maximum enhancement as compared to the other cases. This may be due to the reason of creation of the void by the rising bubbles while flowing along the fluid which is to be filled by the surrounding fluid thus creating turbulence in the flowing fluid causing more heat to be carried out from the surfaces by the cooling fluid. Moreover, it has been found from the earlier studies that as the number of air bubbles injected increases, the heat transfer rate also increases. The air bubble injected at the tube inlet also enhanced the heat transfer rate but was less than the previous case discussed but more than the case where no air bubble is injected. This may be due to the fact that the rising air bubbles create more turbulence than the air bubbles entering along the fluid at the tube inlet. Moreover air bubbles injected throughout the tube has more number of air bubbles than the air bubbles injected at the tube inlet and thus less turbulence is created. From the figures 3 & 4, it has been shown that the air bubbles injected throughout the tube containing 0.1% v/v and 0.2% v/v of  $\text{Al}_2\text{O}_3$  nanoparticles in the water base fluid increased the heat transfer rate by 23-38% and 25-40% respectively depending upon the different Reynolds number while injection of air bubbles at the tube inlet for 0.1% v/v and 0.2% v/v of  $\text{Al}_2\text{O}_3$  nanoparticles in the water base fluid increased the heat transfer rate by 18-28% and 20-30% respectively as compared to the case when air bubbles were not injected.

From the figures 5 & 6, it has been noticed that by keeping the constant flow rate (3.5lpm) of hot and cold fluid and increasing the hot water temperature, heat transfer rate was found to be enhanced. This caused the more difference of temperature between the hot and the cold fluid allowing more heat to be absorbed by the cold fluid. The heat transfer rate was found to be enhanced more in case of air bubble injection. The greatest enhancement in heat transfer rate was found to be in the case where air bubbles were injected throughout the tube followed by the case where air bubbles injected at the tube inlet and the case where no air bubble is injected. Moreover, the increment in the heat transfer rate was found to be more in case of 0.2% v/v of  $\text{Al}_2\text{O}_3$  nanoparticles in the water base fluid than 0.1% v/v of  $\text{Al}_2\text{O}_3$  nanoparticles in the water base fluid because the enhancement in heat transfer characteristics is directly proportional to the volumetric concentration of nanoparticles added in the base fluid.

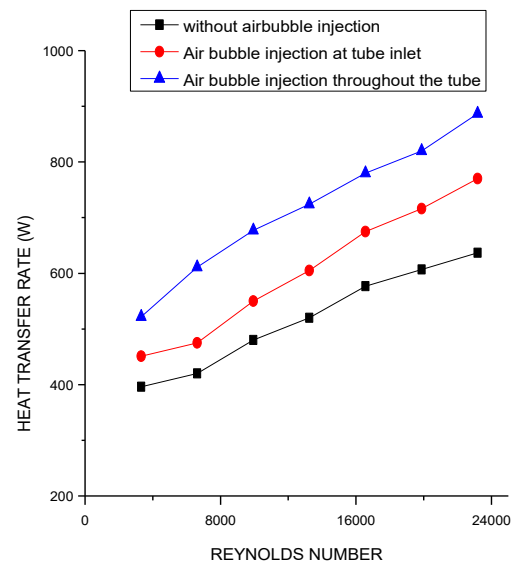


Fig. 3: Heat Transfer Rate Vs Reynolds Number at 0.1% V/V of  $\text{Al}_2\text{O}_3$  Nanoparticles in the Water.

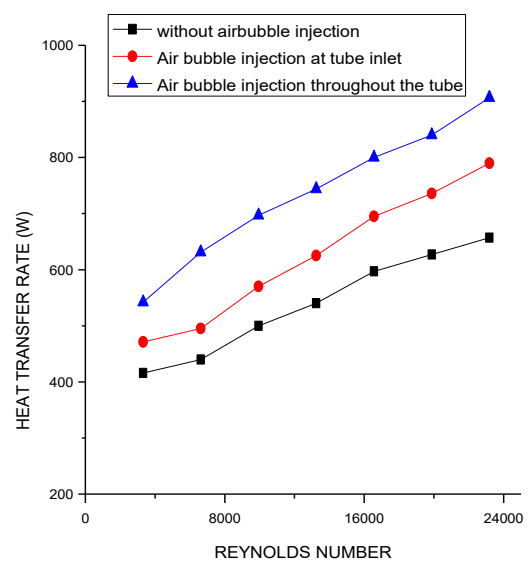


Fig. 4: Heat Transfer Rate Vs Reynolds Number at 0.2% V/V of  $\text{Al}_2\text{O}_3$  Nanoparticles in the Water.

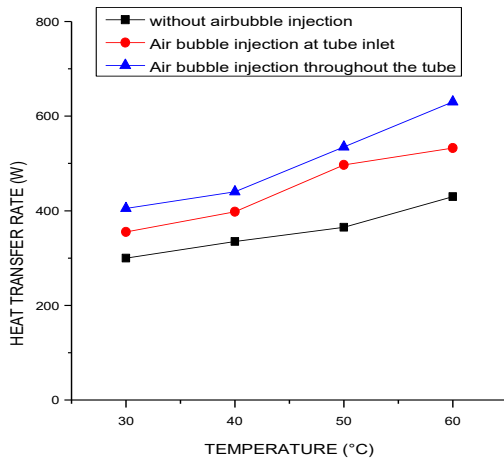


Fig. 5: Heat Transfer Rate vs. Temperature at 0.1% V/V of Al<sub>2</sub>O<sub>3</sub> Nanoparticles in the Water.

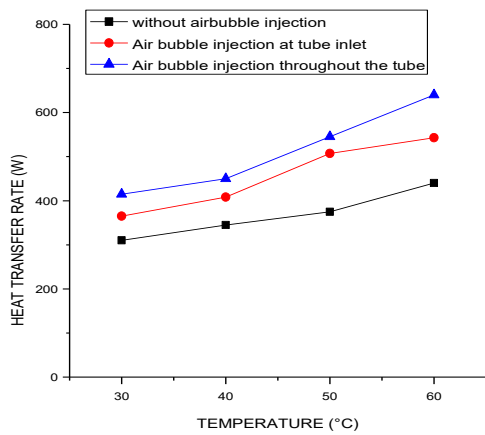


Fig. 6: Heat Transfer Rate Vs Temperature at 0.2% V/V of Al<sub>2</sub>O<sub>3</sub> Nanoparticles in the Water.

5.2. Effect on the dimensionless exergy loss:

It is important to consider the analysis of loss of exergy in any heat exchanger. Exergy is the maximum possible useful work obtained from the system. Obtaining maximum work from the system means obtaining better performance of the heat exchanger. In any heat exchanger, one of the main causes of exergy loss is the difference of temperature between the cold and the hot fluid. As the dimensionless exergy loss is increased, there would be more amount of energy being utilized from the system. From the figures 7 & 8, it has been shown that the air bubbles injected throughout the tube containing 0.1% v/v and 0.2% v/v of Al<sub>2</sub>O<sub>3</sub> nanoparticles in the water base fluid enhanced the dimensionless exergy loss by 33-43% and 35-45% respectively depending upon the range of Reynolds number while the injection of air bubbles at the tube inlet for 0.1% v/v and 0.2% v/v of Al<sub>2</sub>O<sub>3</sub> nanoparticles in the water base fluid enhanced the dimensionless exergy loss by 18-28% and 20-30% respectively as compared to the case when air bubbles were not injected. The injection of air bubbles at tube inlet and throughout the tube showed enhancement in dimensionless exergy loss than without air bubble injection and the reasons for the enhancement have been discussed earlier in section 5.1.

From the figures 9 & 10, it has been shown that as there is rise in the temperature of the hot water keeping the flow rate of the hot fluid and cold fluid to be constant at 3.5lpm, the dimensionless exergy loss also enhances. It has also been found that the dimensionless exergy loss was found to be maximum for the case where air bubbles were injected throughout the tube which was followed

by the air bubble injection at tube inlet case and without air bubble injection case.

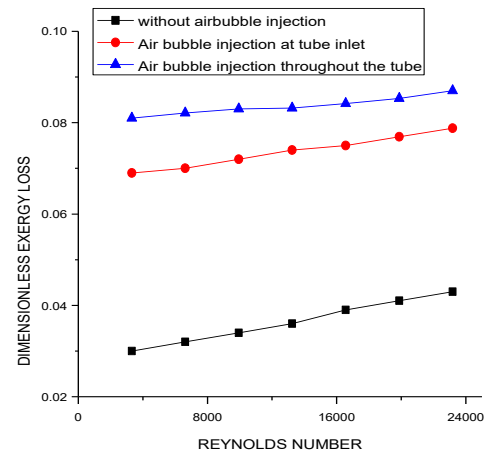


Fig. 7: Dimensionless Exergy Loss Vs Reynolds Number at 0.1% V/V of Al<sub>2</sub>O<sub>3</sub> Nanoparticles in the Water.

Moreover, the enhancement in the dimensionless exergy loss was found to be more in case of 0.2% v/v of Al<sub>2</sub>O<sub>3</sub> nanoparticles in the water base fluid than 0.1% v/v of Al<sub>2</sub>O<sub>3</sub> nanoparticles in water base fluid because the enhancement in heat transfer characteristics is directly proportional to the volumetric concentration of nanoparticles added in the base fluid.

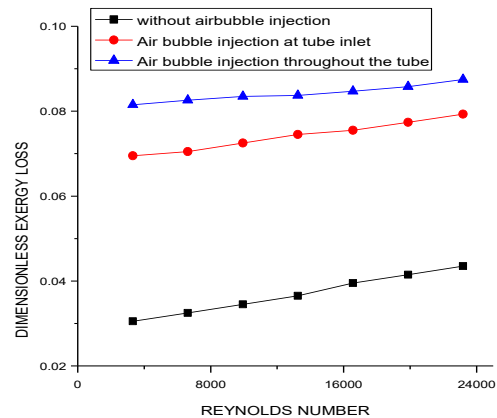


Fig. 8: Dimensionless Exergy Loss Vs Reynolds Number at 0.2% V/V of Al<sub>2</sub>O<sub>3</sub> Nanoparticles in the Water.

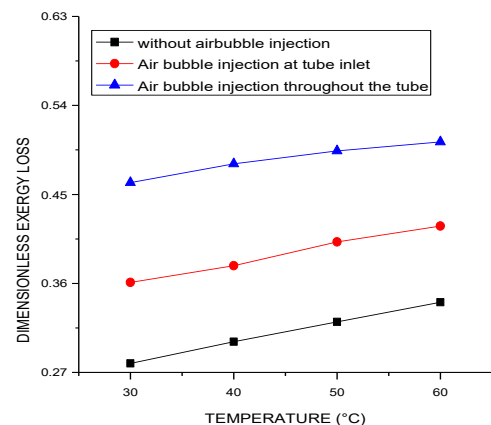
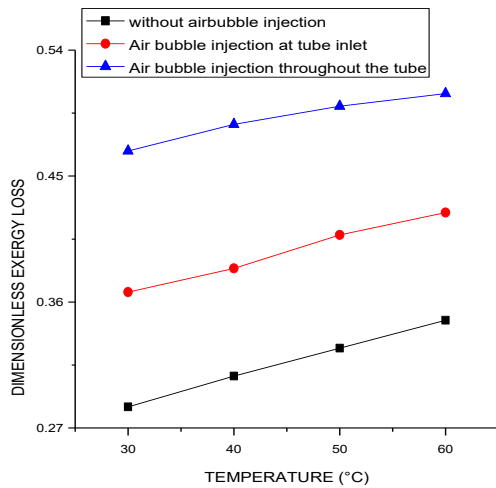


Fig. 9: Dimensionless Exergy Loss Vs Temperature at 0.1% V/V of Al<sub>2</sub>O<sub>3</sub> Nanoparticles in the Water.

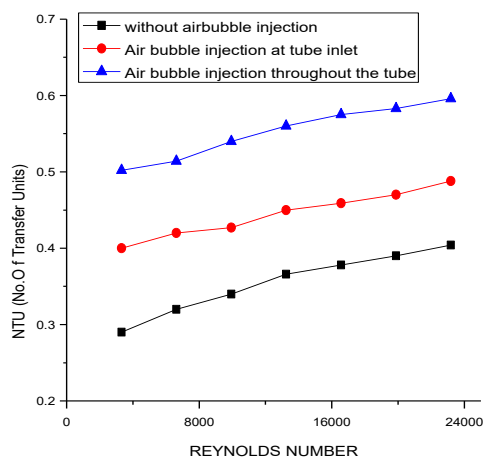


**Fig. 10:** Dimensionless Exergy Loss Vs Temperature at 0.2% V/V of Al<sub>2</sub>O<sub>3</sub> Nanoparticles in the Water.

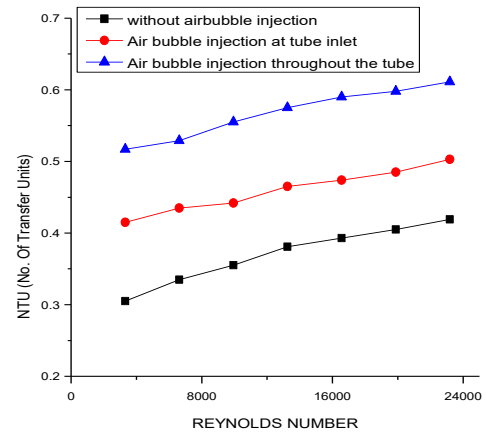
### 5.3. Effect on the NTU (number of transfer units)

NTU is a method used to evaluate the amount of heat transferring in a heat exchanger. It is one of the major heat transfer characteristics which determine the size of heat transferring area and the performance of heat exchanger. As the value of NTU increases, the heat transfer rate increases due to increase in heat transfer area with increase in the value of NTU. From the figures 11 & 12, it has been shown that the air bubbles injected throughout the tube containing 0.1% v/v and 0.2% v/v of Al<sub>2</sub>O<sub>3</sub> nanoparticles in the water base fluid enhanced the NTU by 43-73% and 45-75% respectively depending upon the range of Reynolds number while the injection of air bubbles at the tube inlet for 0.1% v/v and 0.2% v/v of Al<sub>2</sub>O<sub>3</sub> nanoparticles in the water base fluid enhanced the NTU by 18-38% and 20-40% respectively as compared to the case when air bubbles were not injected. The injection of air bubbles at tube inlet and throughout the tube showed the enhancement in NTU than without air bubble injection and the reasons for the enhancement have been discussed earlier in section 5.1 and section 5.2.

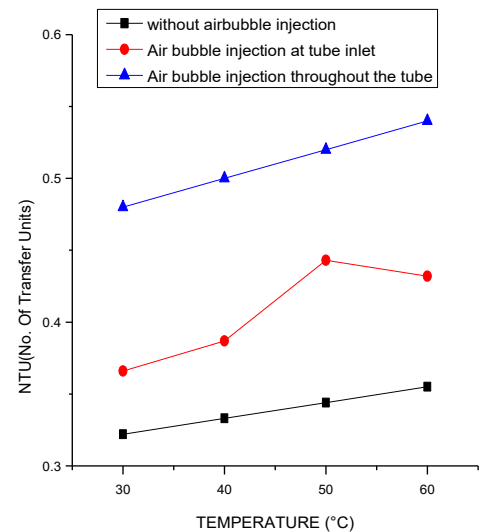
From the figures 13 & 14, it has been shown that as there is rise in the temperature of the hot water keeping the flow rate of the hot fluid and cold fluid to be constant at 3.5lpm, the NTU loss also enhances. This is due to increase in the difference of temperature between the hot and the cold fluid that increases the heat transfer rate and thus ultimately increasing the value of NTU.



**Fig. 11:** NTU (No. of Transfer Units) Vs Reynolds Number at 0.1% V/V of Al<sub>2</sub>O<sub>3</sub> Nanoparticles in the Water.

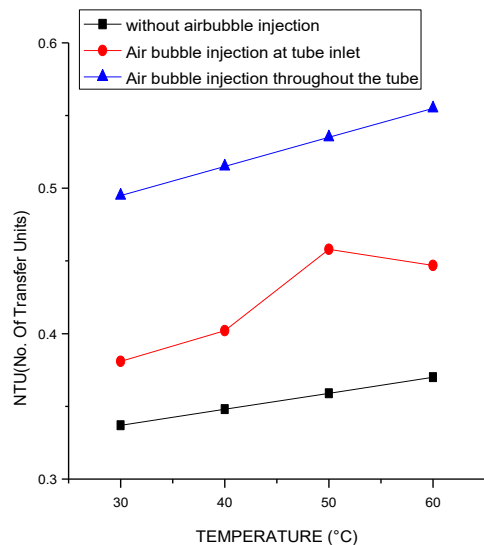


**Fig. 12:** NTU (No. of Transfer Units) Vs Reynolds Number at 0.2% V/V of Al<sub>2</sub>O<sub>3</sub> Nanoparticles in the Water.



**Fig. 13:** NTU (No. of Transfer Units) Vs Temperature at 0.1% V/V of Al<sub>2</sub>O<sub>3</sub> Nanoparticles in the Water.

It has also been found that the NTU was found to be maximum for the case where air bubbles were injected throughout the tube which was followed by the air bubble injection at tube inlet case and without air bubble injection case. Moreover, the enhancement in the NTU found to be more in case of 0.2% v/v of Al<sub>2</sub>O<sub>3</sub> nanoparticles in the water base fluid than 0.1% v/v of Al<sub>2</sub>O<sub>3</sub> nanoparticles in the water base fluid because the enhancement in heat transfer characteristics is directly proportional to the volumetric concentration of nanoparticles added in the base fluid.



**Fig. 14:** NTU (No. of Transfer Units) Vs Temperature at 0.2% V/V of  $\text{Al}_2\text{O}_3$  Nanoparticles in the Water.

## 6. Conclusions

Following conclusions were made from the above study done:

Air bubble injection is one of the cheapest and promising techniques to enhance the thermal performance of a heat exchanger.

**CONDITION A:** Shell and tube heat exchanger containing hot water on shell side and water based  $\text{Al}_2\text{O}_3$  cold nanofluid with 0.1% v/v of  $\text{Al}_2\text{O}_3$  nanoparticles taken on tube side.

- 1) The heat transfer rate showed an enhancement of about 23-38% when air bubbles were injected throughout the tube and an enhancement of nearly 18-28% in the heat transfer rate was found during the injection of air bubbles at the tube inlet as compare to without air bubble injection at different Reynolds number.
- 2) The dimensionless exergy loss showed an enhancement of about 33-43% when air bubbles were injected throughout the tube and an enhancement of nearly 18-28% in the dimensionless exergy loss was found during the injection of air bubbles at the tube inlet as compare to without air bubble injection at different Reynolds number.
- 3) The NTU showed an enhancement of about 43-73% when air bubbles were injected throughout the tube and an enhancement of nearly 18-38% in the heat transfer rate was shown during the injection of air bubbles at the tube inlet as compare to without air bubble injection at different Reynolds number.
- 4) The heat transfer rate, dimensionless exergy loss and the NTU showed an enhancement in their values on increasing the temperature of the hot fluid. The maximum enhancement was found to be in the case where injection of air bubble was done throughout the tube which was followed by the air bubble injection at the tube inlet and without air bubble injection with increase in the temperature of the hot fluid.

**CONDITION B:** Shell and tube heat exchanger containing hot water on shell side and water based  $\text{Al}_2\text{O}_3$  cold nanofluid with 0.2% v/v of  $\text{Al}_2\text{O}_3$  nanoparticles taken on tube side.

- 5) The heat transfer rate showed an enhancement of about 25-40% when air bubbles were injected throughout the tube and an enhancement of nearly 20-30% in the heat transfer rate was shown during the injection of air bubbles at the tube inlet as compare to without air bubble injection at different Reynolds number.
- 6) The dimensionless exergy loss showed an enhancement of about 35-45% when air bubbles were injected throughout the tube and an enhancement of nearly 20-30% in the di-

dimensionless exergy loss was shown during the injection of air bubbles at the tube inlet as compare to without air bubble injection at different Reynolds number.

- 7) The NTU showed an enhancement of about 45-75% when air bubbles were injected throughout the tube and an enhancement of nearly 20-40% in the heat transfer rate was shown during the injection of air bubbles at the tube inlet as compare to without air bubble injection at different Reynolds number.
- 8) The heat transfer rate, dimensionless exergy loss and the NTU showed an enhancement in their values on increasing the temperature of the hot fluid. The enhancement in the heat transfer characteristics found to be more in condition 2 than in condition 1. The maximum enhancement was found to be in the case where injection of air bubble was done throughout the tube which was followed by the air bubble injection at the tube inlet and without air bubble injection with increase in the temperature of the hot fluid.

## References

- [1] Kahrom, M., Haghparast, P. and Javadi, S.M. (2010) Optimization of heat transfer enhancement of flat plate based on pereto genetic algorithm, *International Journal of Engineering, Transaction A: Basics*, 23, 177-190.
- [2] Ahmadvadehtalatapeh, M. and Yau, Y.H. (2012), Energy conservation potential of heat pipe heat exchanger: Experimental study and predictions, *International Journal of Engineering Transaction B: Applications*, 25, 193-199.
- [3] Cancan, Z., Yafei, L., Li, W., Ke, X. and Jinxing, W., (2014), Review heat exchanger: Research development of self-rotating inserts in heat exchanger tubes, *International Journal of Engineering-Transactions A: Basics*, 27, 15-26.
- [4] Saleh K, Abdolrahman D, (2017), Effect of air bubble injection on the performance of a horizontal helical shell and coiled tube heat exchanger, *Applied Thermal Engineering*, 111, 676-683. <https://doi.org/10.1016/j.applthermaleng.2016.09.101>.
- [5] Celata, GP, Chairadia, A, M. Cumo and F.D. Annibale, (1999), Heat transfer enhancement by air injection in upward heated mixed convection flow of water, *International Journal of Multiphase Flow*, 25, 1033-1052. [https://doi.org/10.1016/S0301-9322\(99\)00059-2](https://doi.org/10.1016/S0301-9322(99)00059-2).
- [6] Dizaji, HS. and Jafarmadar, S. (2014), Heat transfer enhancement due to air bubble injection into a horizontal double pipe heat exchanger, *International Journal of Automotive Research*, 4, 902-910.
- [7] Gabillet, C, Colin, C., Fabre, J., (2002) Experimental study of bubble injection in a turbulent boundary layer, *International Journal of Multiphase Flow*, 28, 553-578. [https://doi.org/10.1016/S0301-9322\(01\)00075-1](https://doi.org/10.1016/S0301-9322(01)00075-1).
- [8] Jiaccai Lu, Arturo F, Gretan T, (2005), the effect of bubbles on the wall drag in turbulent flow, *Physics of Fluids*, 17, 095102. <https://doi.org/10.1063/1.2033547>.
- [9] Mattson, M., Mahesh, K., (2011), Simulation of bubble injection in a turbulent boundary layer, *Physics of Fluid*, 23, 045107. <https://doi.org/10.1063/1.3560382>.
- [10] Jakob, B, Oliveri A., Miozzi, MEF, Campana, R. Piva, (2010), Drag reduction by microbubble in a turbulent boundary layer, *Physics of Fluid*, 22.
- [11] Nandan, A. and Singh, G. (2016) Experimental study of heat transfer rate in a shell and tube heat exchanger with air bubble injection, *International Journal of Engineering Transaction B: Applications*, 29, 1160-1166.
- [12] D.Q. Kern, Process Heat Transfer, McGraw-Hills, New York, 1950.
- [13] Baghban, S.N., Moghiman, M. and Salehi, E., (2000), Thermal analysis of shell-side flow of shell-and tube heat exchanger using experimental and theoretical methods, *International Journal of Engineering*, 13, 15-26.
- [14] Aghabozorg, M.H., Rashidi, A. and Mohammadi, S., (2016), Experimental investigation of heat transfer enhancement of  $\text{Fe}_3\text{O}_4$ -water magnetic nanofluids under laminar, transient and turbulent flow inside a horizontal shell and tube heat exchanger, *Experimental Thermal and Fluid Science*, 72, 182-189. <https://doi.org/10.1016/j.expthermflusci.2015.11.011>.
- [15] Fotukian, SM, Esfahany MN, (2010) Experimental study of turbulent convective heat transfer and pressure drop of dilute CuO/water nanofluid inside a circular tube, *International Communications in Heat and Mass Transfer* 37, 214-219 <https://doi.org/10.1016/j.icheatmasstransfer.2009.10.003>.

- [16] Yajie R, Huaqing Xie and An C, (2005) Effective thermal conductivity of nanofluids containing spherical nanoparticles, *Journal of Physics D: Applied Physics*, 38, 3958–3961. <https://doi.org/10.1088/0022-3727/38/21/019>.
- [17] Sundar LS, Farooky MH, Sarada SN, Singh MK, (2013) Experimental thermal conductivity of ethylene glycol and water mixture based low volume concentration of  $Al_2O_3$  and CuO nanofluids, *International Communications in Heat and Mass Transfer*, 41 41–46. <https://doi.org/10.1016/j.icheatmasstransfer.2012.11.004>.
- [18] K. RP, Suganthi KS, Rajan, K.S., (2012), Transport properties of ultra-low concentration CuO–water nanofluids containing non-spherical nanoparticles, *International Journal of Heat and Mass Transfer*, 55 4734–4743. <https://doi.org/10.1016/j.ijheatmasstransfer.2012.04.035>.
- [19] Xiaohao Wei, Haitao Zhu, Tiantian Kong, Liqiu Wang, "Synthesis and thermal conductivity of Cu<sub>2</sub>O nanofluids" *International Journal of Heat and Mass Transfer* 52 (2009) 4371–4374. <https://doi.org/10.1016/j.ijheatmasstransfer.2009.03.073>.
- [20] Prashant, Gurpreet Singh, Tejiner Pal Singh Sarao, "Experimental Investigation of Heat Transfer Characteristics of Plate Heat Exchanger using Alumina - Water based Nanofluids at Different Orientations" *Indian Journal of Science and Technology*, Vol 9, No. 48, (2016), 0974-5645.
- [21] Swati Singh, Gurpreet Singh and Amit Singla, "Experimental Studies on Heat Transfer Performance of Double Pipe Heat Exchanger with using Baffles and Nanofluids" *Indian Journal of Science and Technology*, Vol 9, No. 40 ,(2016), 0974-5645.
- [22] Gaurav Thakur and Gurpreet Singh, experimental investigation of heat transfer characteristics in  $Al_2O_3$  – water based nanofluids operated shell and tube heat exchanger with air bubble injection" *International Journal of Mechanical and Production Engineering Research and Development* Vol.7, No.4, (2017), 263-274. <https://doi.org/10.24247/ijimperdaug201727>.